

WIFI 6E WIFI7

ONBOARD SMD STAMPED METAL ANTENNA

2400-2500 MHz | 5100-7125 MHz



Dimensions: 12.0 x 10.46 x 3.0 mm

Clearance Area: 45.0 x 15.7 mm

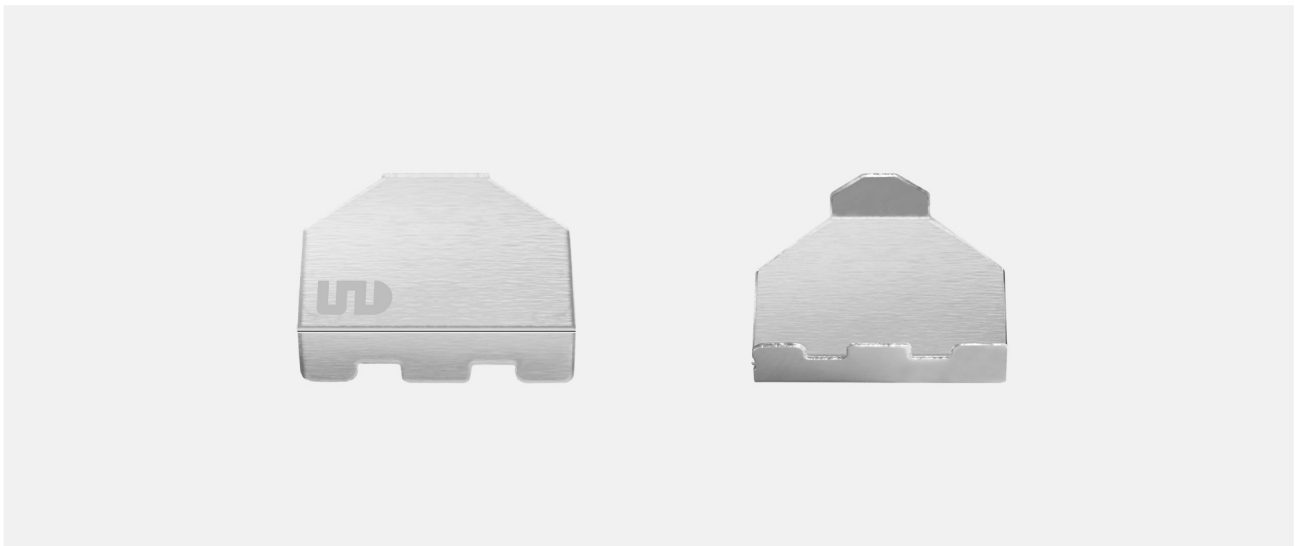

Model: ADWM002
PN: M01-X01210W232





Table of Contents

1 FEATURES & BENEFITS	1
2 APPLICATIONS	1
3 ORDER INFORMATION	1
4 REFERENCE GUIDE.....	2
5 EVALUATION BOARD WITH ANTENNA	2
6 MATCHING NETWORK	3
7 RECOMMENDED FOOTPRINT AND LAYOUT.....	4
8 ELECTRICAL PERFORMANCE.....	5
8.1 VSWR, Return Loss(S11, S22) and Isolation(S21).....	5
8.2 Gain and Total Efficiency	6
8.3 2D and 3D Radiation Patterns (2400-2500 MHz)	8
8.4 2D and 3D Radiation Patterns (5100-5800 MHz).....	10
8.5 2D and 3D Radiation Patterns (5925-7125 MHz)	12
9 SOLDERING CONDITIONS	14
10 PACKAGING.....	14
10.1 Optimal Storage Conditions for Packaged Reels	14
10.2 Packagings and Dimensions (Unit: mm).....	15
11 ANTENNA CERTIFICATION	16
WELCOME ALL ANTENNA OEM/ODM PROJECTS	17

www.aboosty.com

The materials provided herein, which are intended for illustration purposes only, are believed to be reliable and correct. However, no responsibility is further assumed for inaccuracies or incompleteness, and all such information shall be entirely at the user's risk. All information is subject to change without prior notice.

Copyright © 2024 ShenZhen MyAntenna RF Technology Co., Ltd. All Rights Reserved.

Abosty™ is owned by Shenzhen MyAntenna RF Technology Co., Ltd. (often abbreviated as MyAntenna).



1 FEATURES & BENEFITS

- Low Profile
- Light Weight
- Easy to Integrate
- Intended for SMD Mounting
- Reduced Cost and Time-to-Market

2 APPLICATIONS

- Wireless Routers and Modems
- Internet of Things (IoT) Devices, M2M
- Indoor Location Tracking and Positioning
- Consumer Tracking
- Smart Metering
- Virtual Reality (VR) and Augmented Reality (AR)

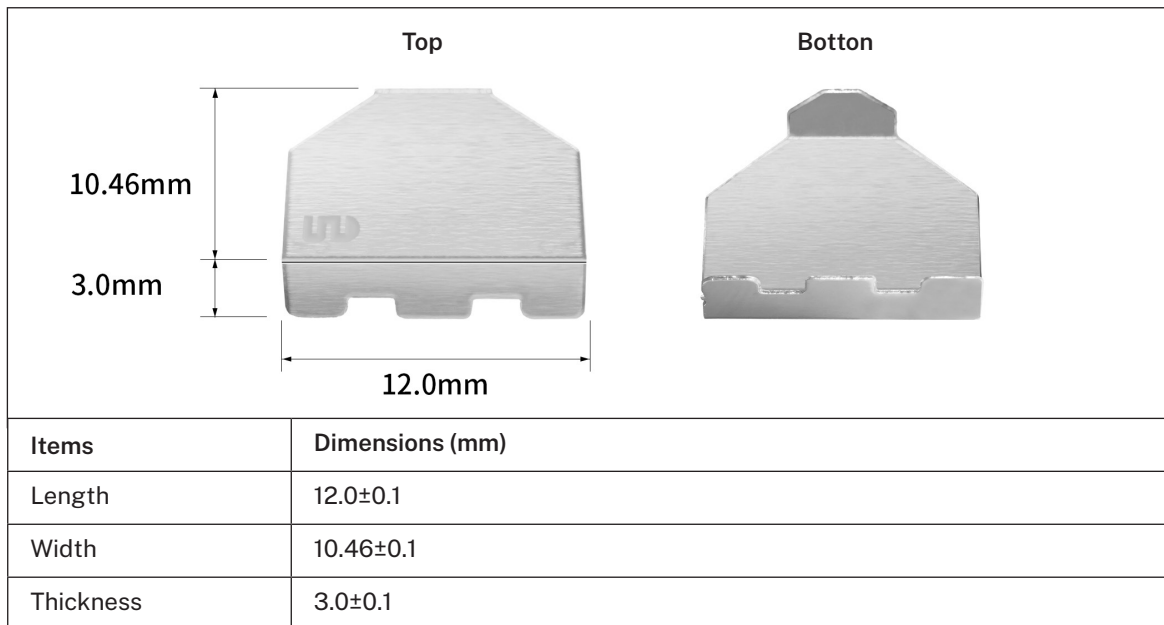

3 ORDER INFORMATION

Product Name	WIFI 6E WIFI7 OnBoard SMD Stamped Metal Antenna
Model	ADWM002
Part Number	M01-X01210W232
Dimensions	12.0 x 10.46 x 3.0 mm
Weight	0.35 g
Mounting	SMT
Packaging	Tape & Reel
MOQ	1200 pcs/reel

4 REFERENCE GUIDE

Antenna	Antenna-Left (ANT 1)		Antenna-Right (ANT 2)	
Technical Features (MHz)	2400-2500	5100-7125	2400-2500	5100-7125
Max VSWR	1.22:1	1.96:1	1.21:1	1.80:1
Max Efficiency	88.43%		92.17%	
Peak Gain	Up to 4.49 dBi (Typ)		Up to 5.64 dBi (Typ)	
Max Return Loss	-11.38 dB		-10.26 dB	
Max Input Power	2 Watts CW			
Polarization	Linear			
Input Impedance	50 Ω			
Operating Temperature	-40°C to +80°C			
Relative Humidity	10 to 70%			
Dimensions (L x W x H)	12.0 x 10.46 x 3.0 mm			
All data were measured in free space and on a reference wground plane of 45 mm length, 35 mm width, and 1.0 mm thickness. Application data might vary.				

5 EVALUATION BOARD WITH ANTENNA

The evaluation board provides operation at 2.2-8.5 GHz.
Evaluation Board dimension: 45.0 x 35.0 x 1.0 mm

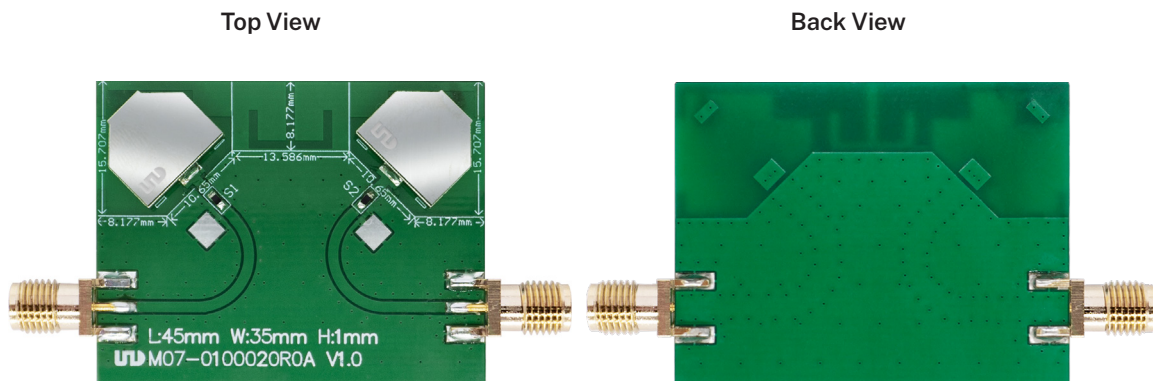

Clearance Area: 45.0 x 15.7 mm

6 MATCHING NETWORK

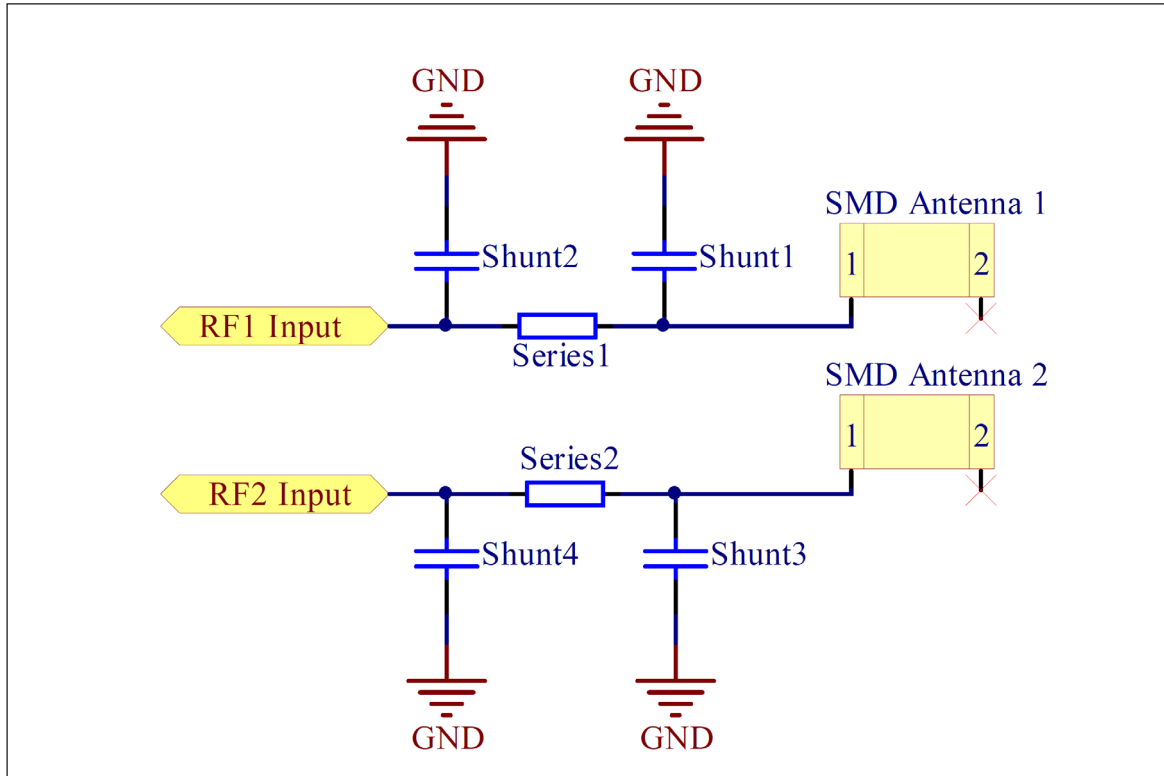

Tag Number	Value	Brand	PN
Series1	RES SMD 0603 package OR $\pm 1\%$	YAGEO	D03-0100450000
Series2	RES SMD 0603 package OR $\pm 1\%$	YAGEO	D03-0100450000
Shunt1	NC		
Shunt2	NC		
Shunt3	NC		
Shunt4	NC		

7 RECOMMENDED FOOTPRINT AND LAYOUT

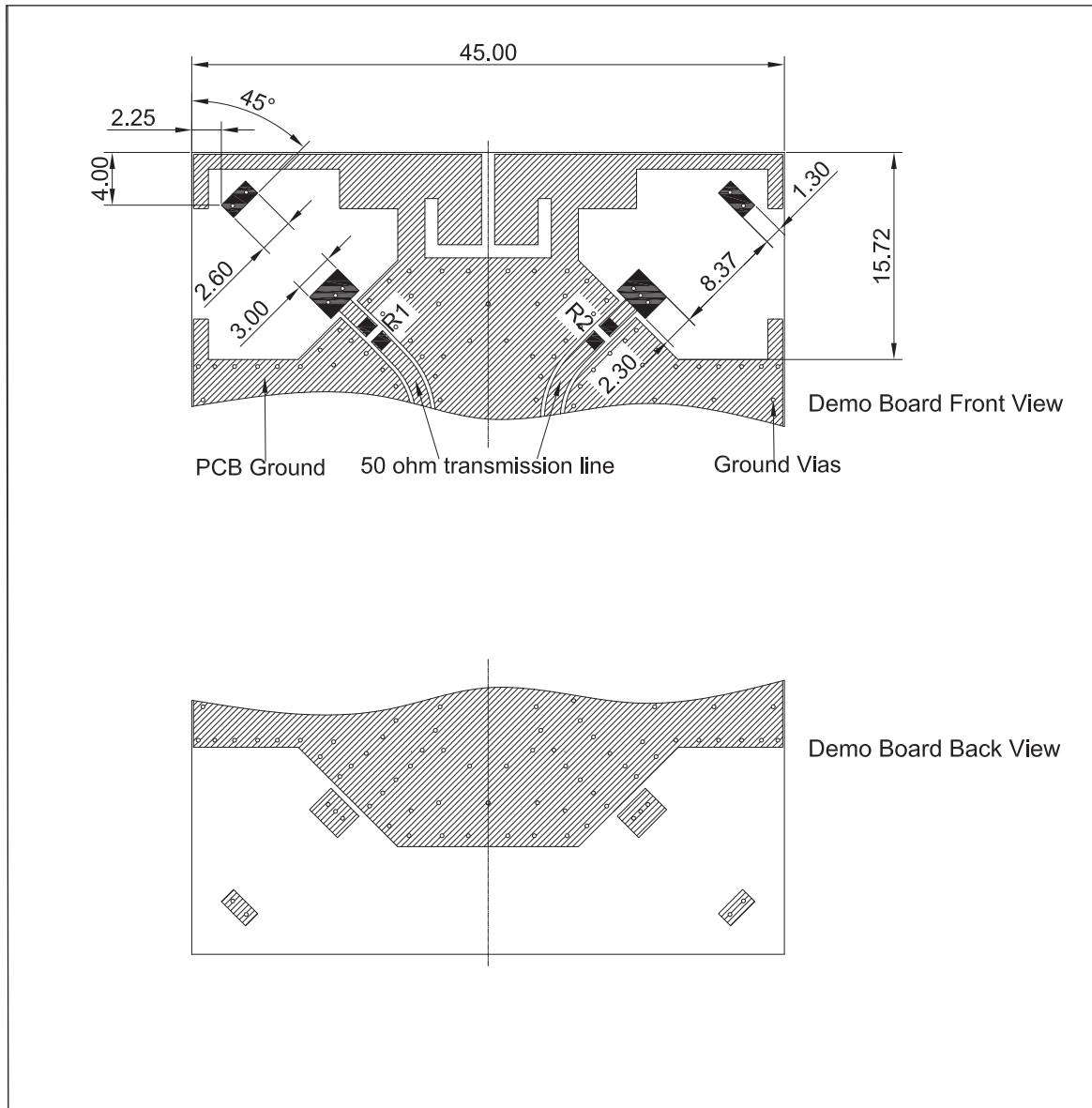

Tag Number	Value	Brand	PN
R1	RES SMD 0603 package 0R ±1%	YAGEO	D03-0100450000
R2	RES SMD 0603 package 0R ±1%	YAGEO	D03-0100450000

8 ELECTRICAL PERFORMANCE

© Note

All data displayed in Chapter 8 were measured in free space and on a reference ground plane of 45 mm length, 35 mm width, and 1.0 mm thickness.

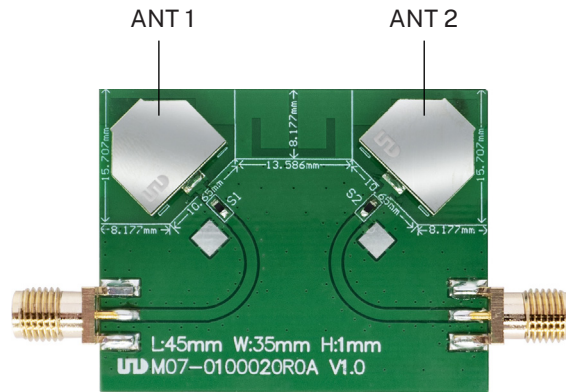

8.1 VSWR, Return Loss(S11, S22) and Isolation(S21)

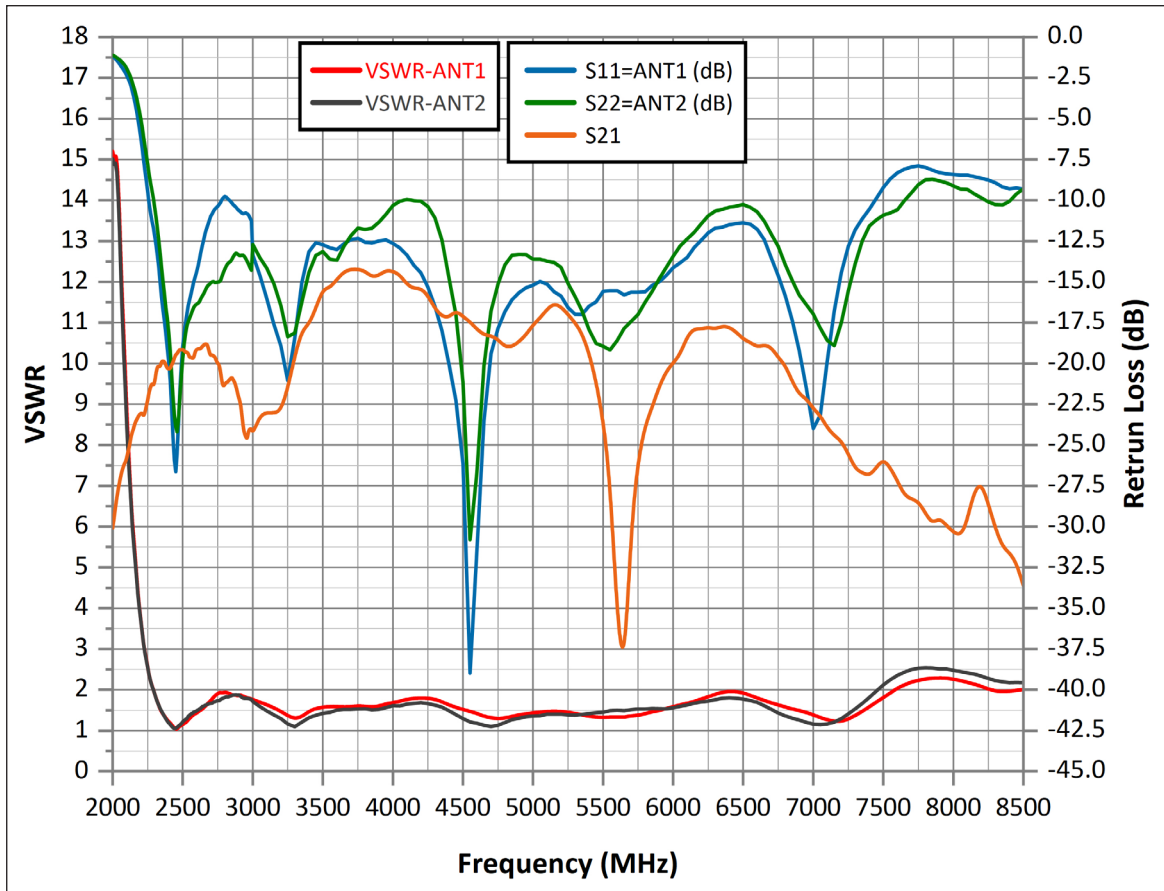



8.2 Gain and Total Efficiency

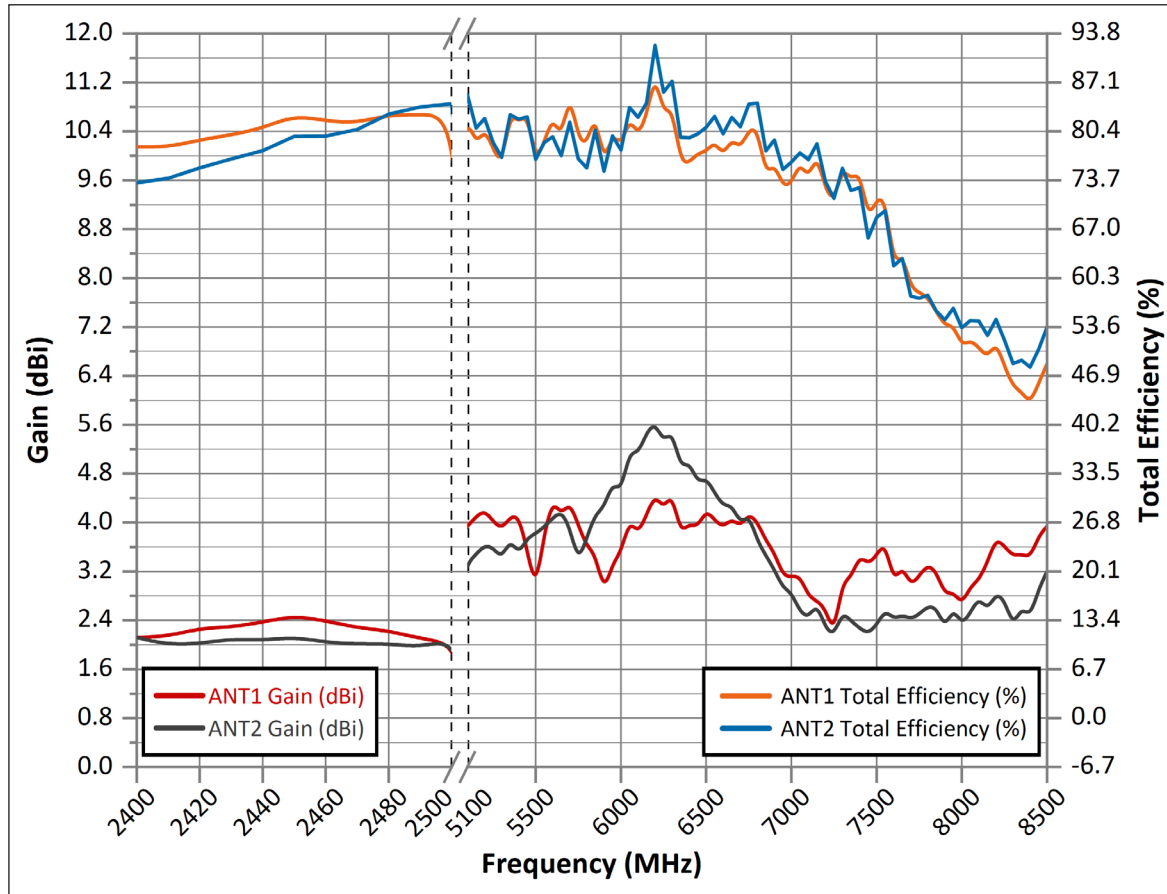

ANT 1 Data					
Freq (MHz)	Gain (dBi)	Efficiency (%)	Freq (MHz)	Gain (dBi)	Efficiency (%)
2400	2.12	78.27	5100	3.94	82.21
2410	2.14	78.24	5300	3.89	75.65
2420	2.27	79.23	5500	2.89	76.31
2430	2.29	79.93	5700	4.34	85.81
2440	2.37	80.84	5900	2.85	75.76
2450	2.48	82.66	6150	4.13	82.47
2460	2.39	81.83	6350	3.81	76.15
2470	2.28	81.53	6550	4.04	79.03
2480	2.23	82.72	6750	4.15	80.62
2490	2.1	82.66	6950	3.13	72.82
2500	2.04	82.77	7150	2.72	77.33



ANT 2 Data					
Freq (MHz)	Gain (dBi)	Efficiency (%)	Freq (MHz)	Gain (dBi)	Efficiency (%)
2400	2.12	73.36	5100	3.34	85.42
2410	2	73.98	5300	3.41	76.84
2420	2.02	75.41	5500	3.82	76.56
2430	2.1	76.62	5700	3.92	81.66
2440	2.07	77.75	5900	4.24	74.95
2450	2.13	79.71	6150	5.47	84.26
2460	2.04	79.76	6350	4.89	79.61
2470	2.01	80.67	6550	4.49	82.46
2480	2.02	82.76	6750	4.13	84.13
2490	1.96	83.73	6950	2.93	75.17
2500	2.09	84.18	7150	2.68	78.69

8.3 2D and 3D Radiation Patterns (2400-2500 MHz)

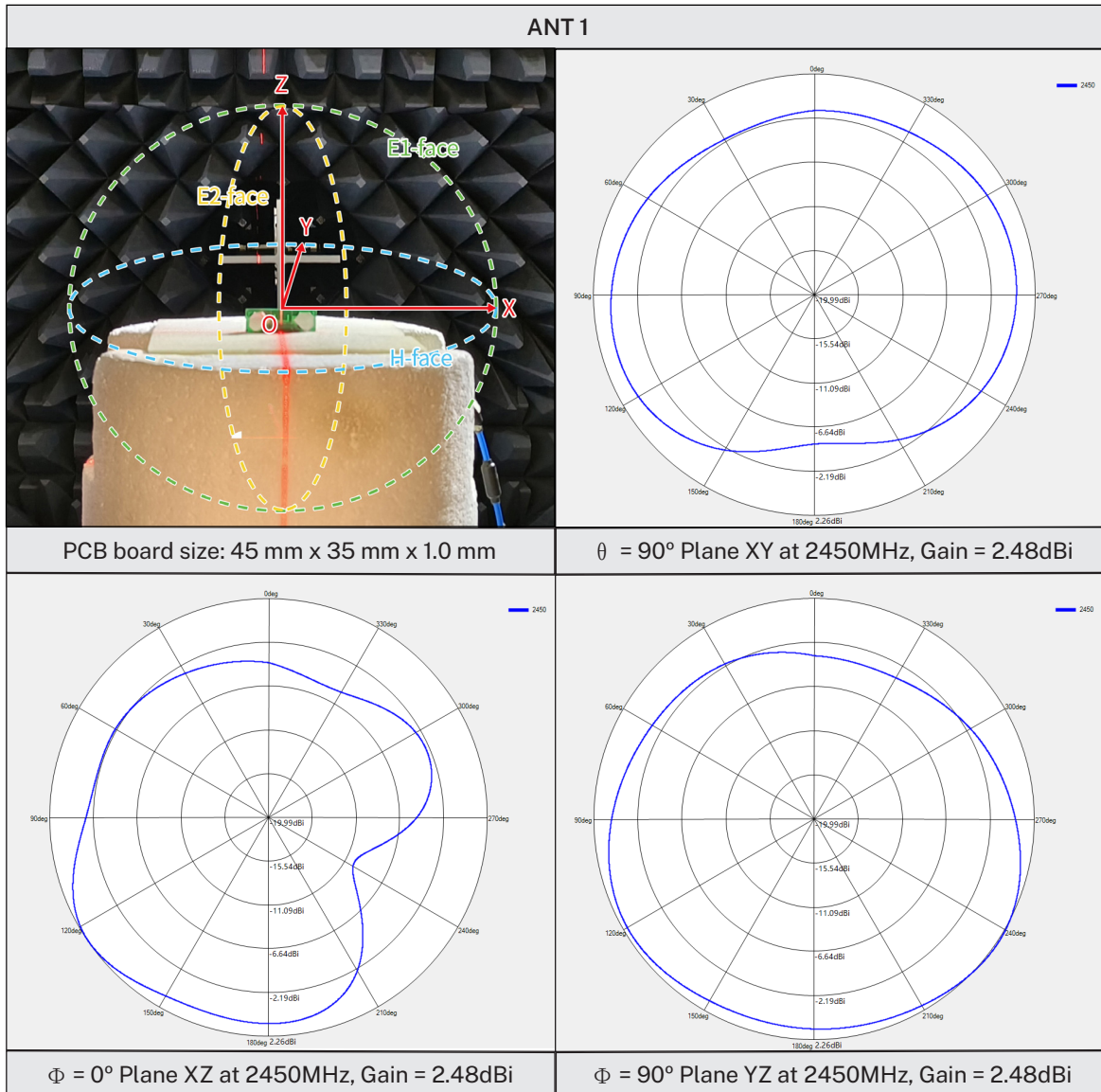

ANT 1 3D radiation patterns
@ 2450 MHz

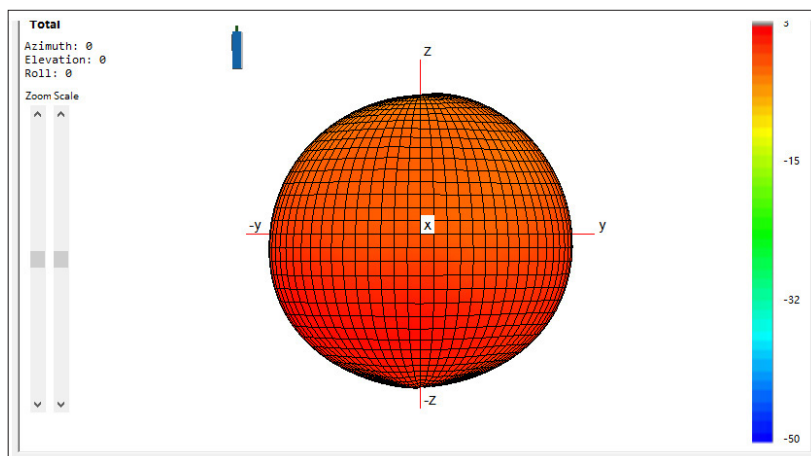

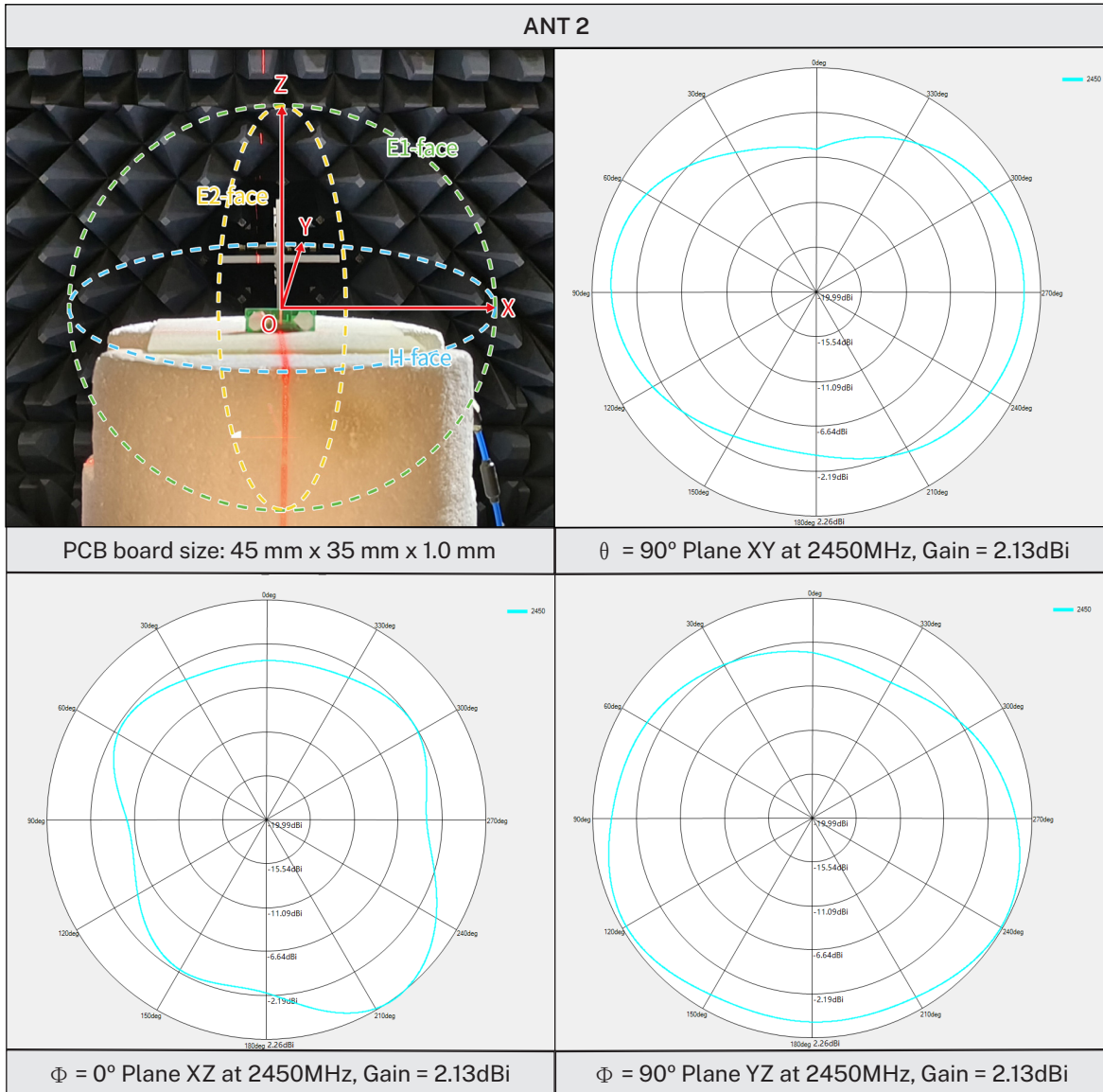

ANT 2 3D radiation patterns
@ 2450 MHz

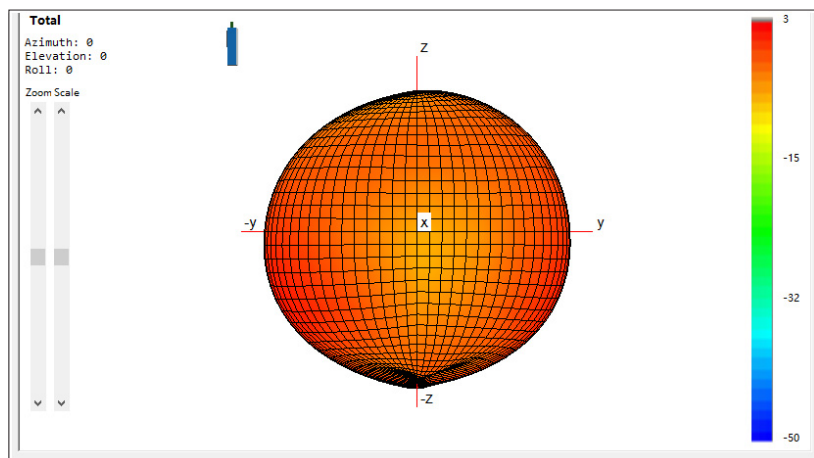

8.4 2D and 3D Radiation Patterns (5100-5800 MHz)

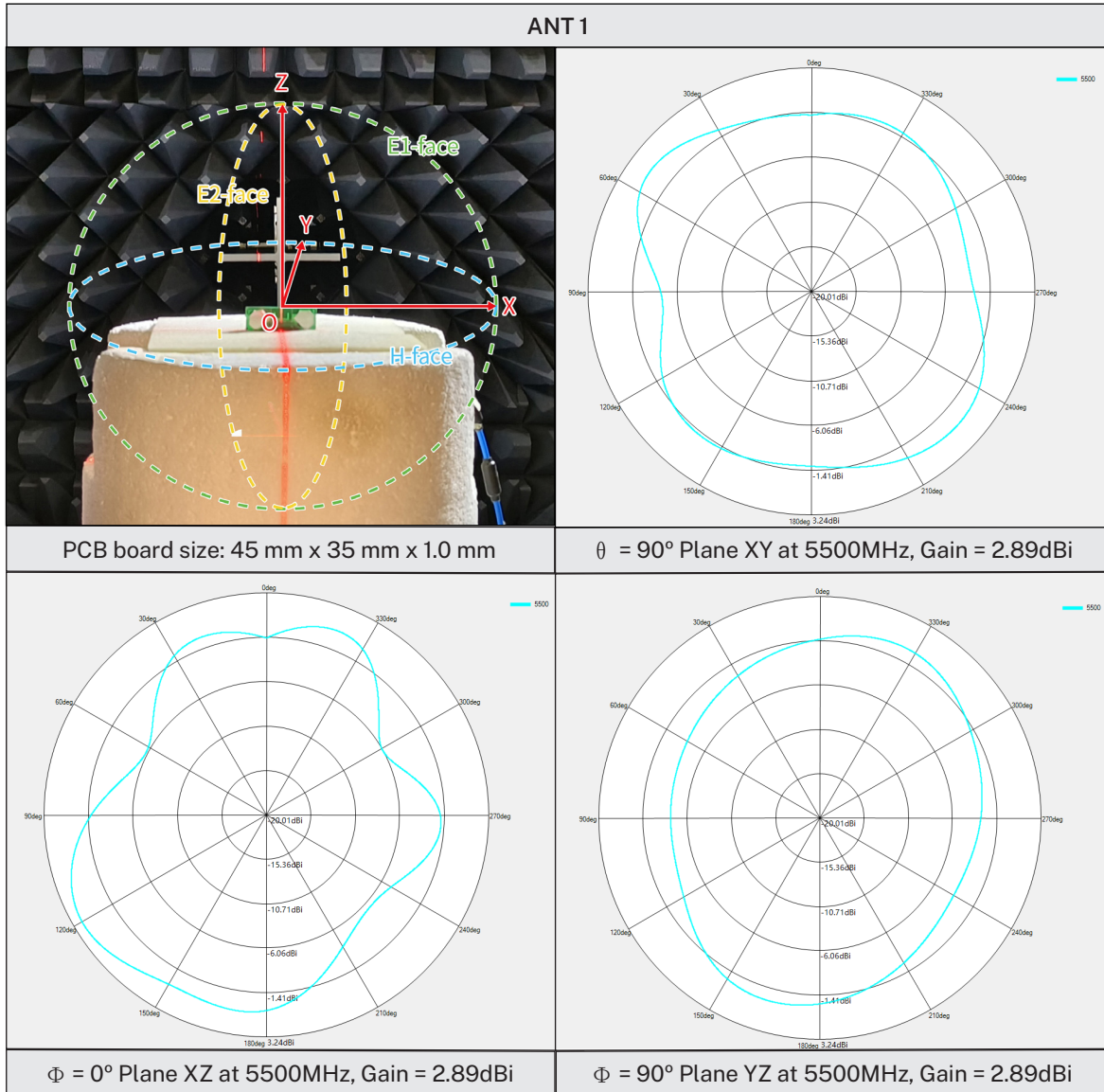

ANT 1 3D radiation patterns
@ 5500 MHz

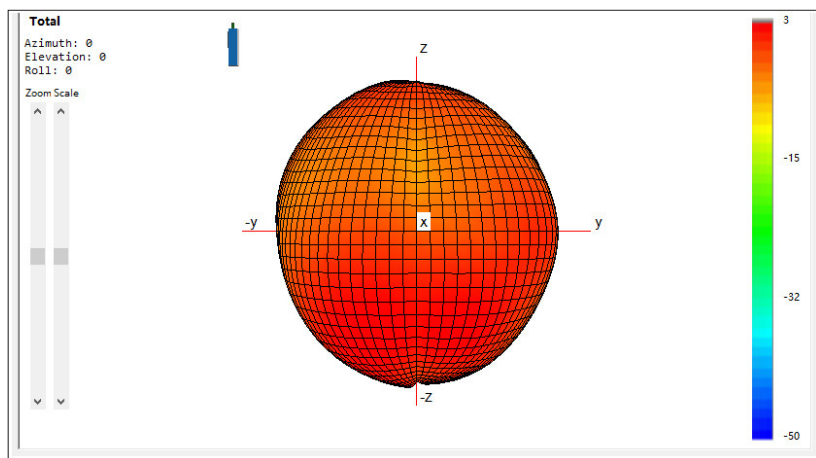

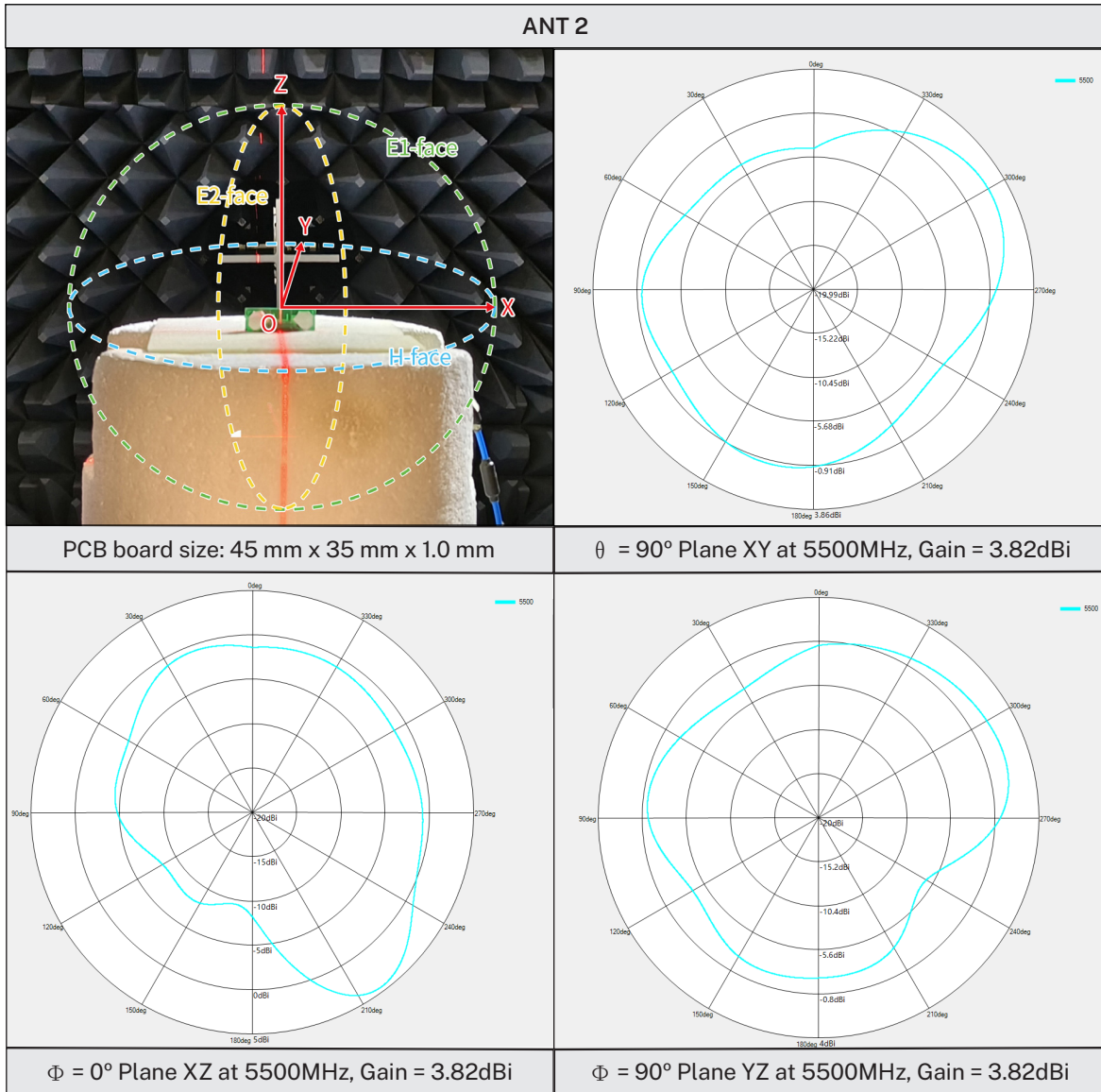

ANT 2 3D radiation patterns
@ 5500 MHz

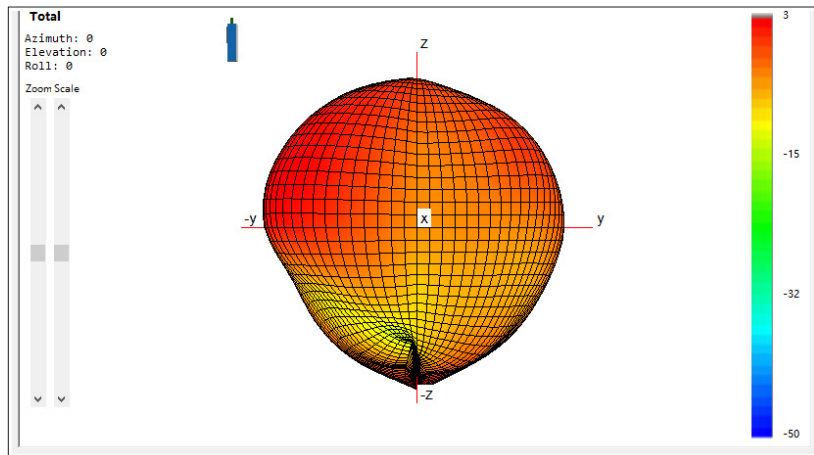

8.5 2D and 3D Radiation Patterns (5925-7125 MHz)

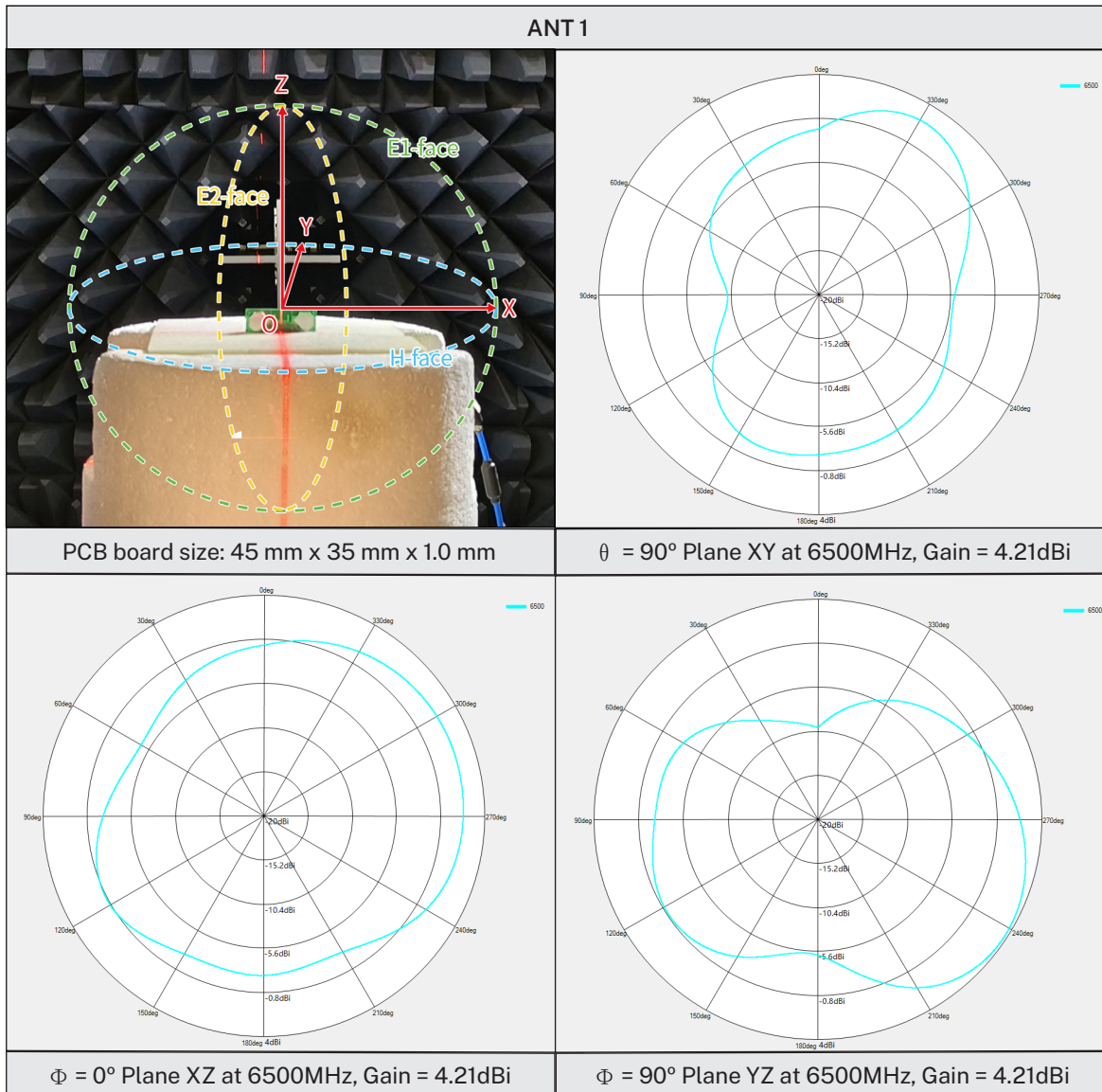

ANT 13D radiation patterns
@ 6500 MHz

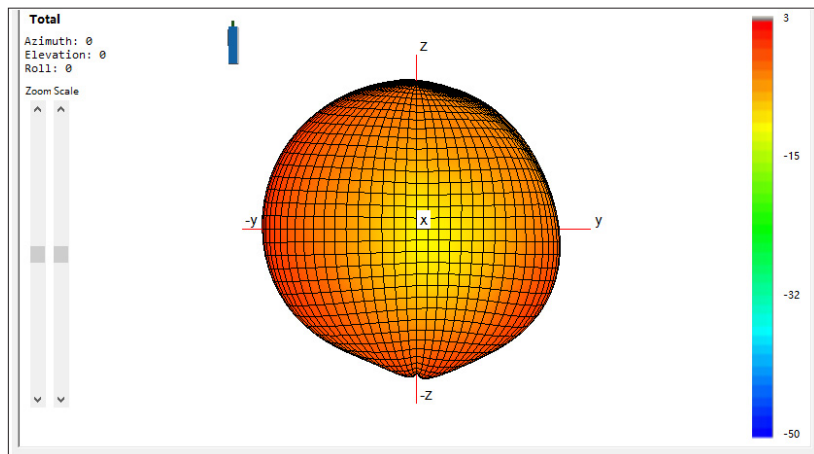

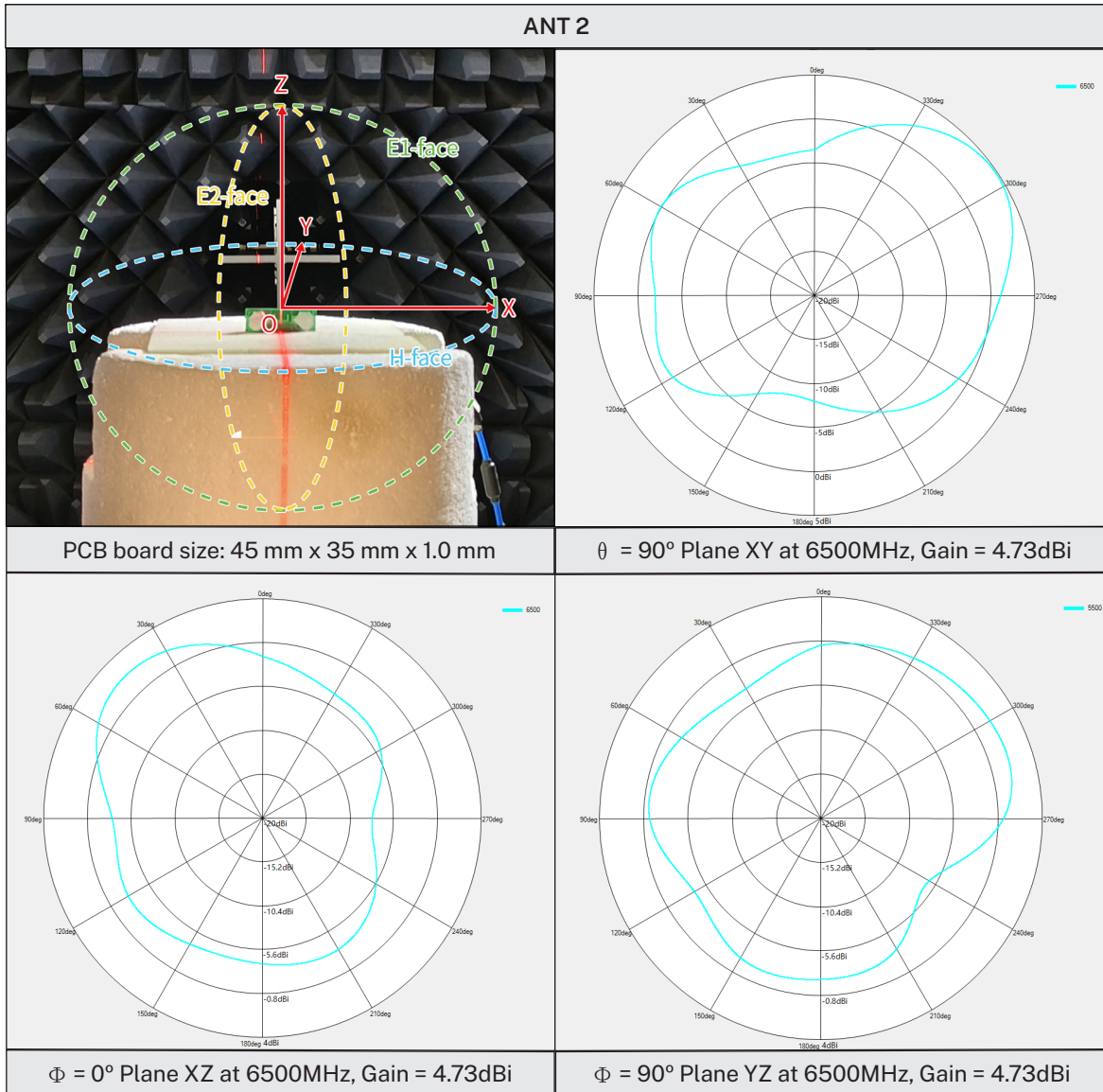

ANT 2 3D radiation patterns
@ 6500 MHz

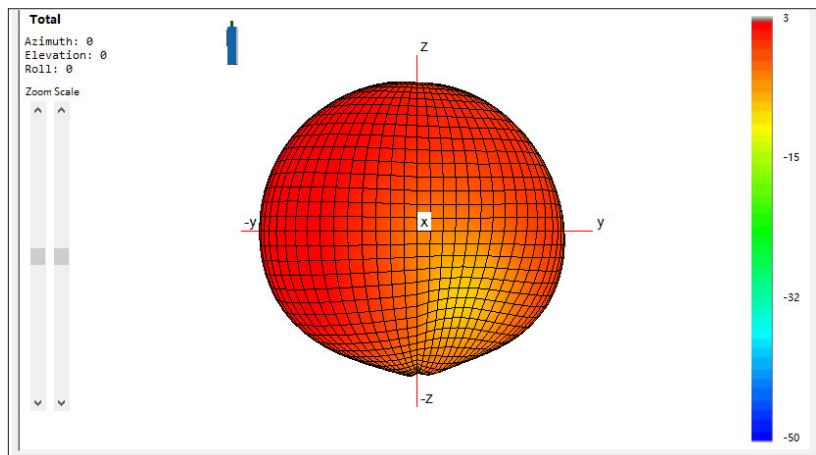

9 SOLDERING CONDITIONS

This antenna is suitable for lead free soldering.

The reflow duration should be adjusted to create good solder joints without raising the antenna temperature beyond the allowed maximum of 260°C.

The figure below shows the temperature profile for soldering.

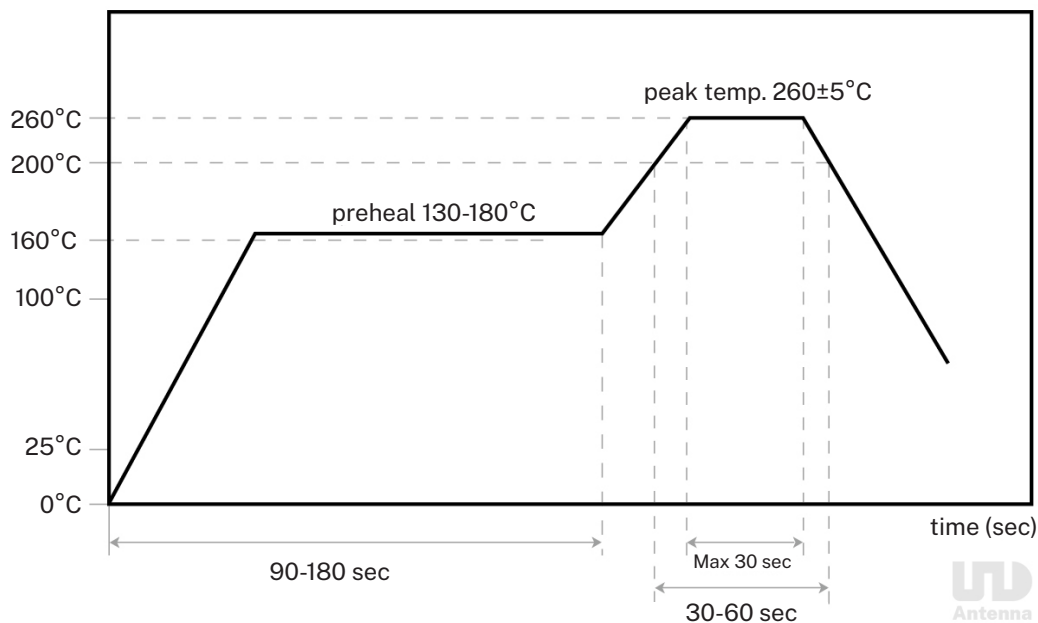

10 PACKAGING

10.1 Optimal Storage Conditions for Packaged Reels

Temperature	-5°C to 40°C
Humidity	Less than 70% RH
Shelf life	18 months
Storage place	Away from corrosive gas and direct sunlight
Packaging	Reels should be stored in unopened sealed manufacturer's plastic packaging.

© **Note**

Storage of open reels of antennas is not recommended due to possible oxidation of pads on antennas. If short-term storage is necessary, then it is highly recommended that the bag containing the antenna reel is re-sealed and stored in like storage conditions as in the above table.

10.2 Packagings and Dimensions (Unit: mm)

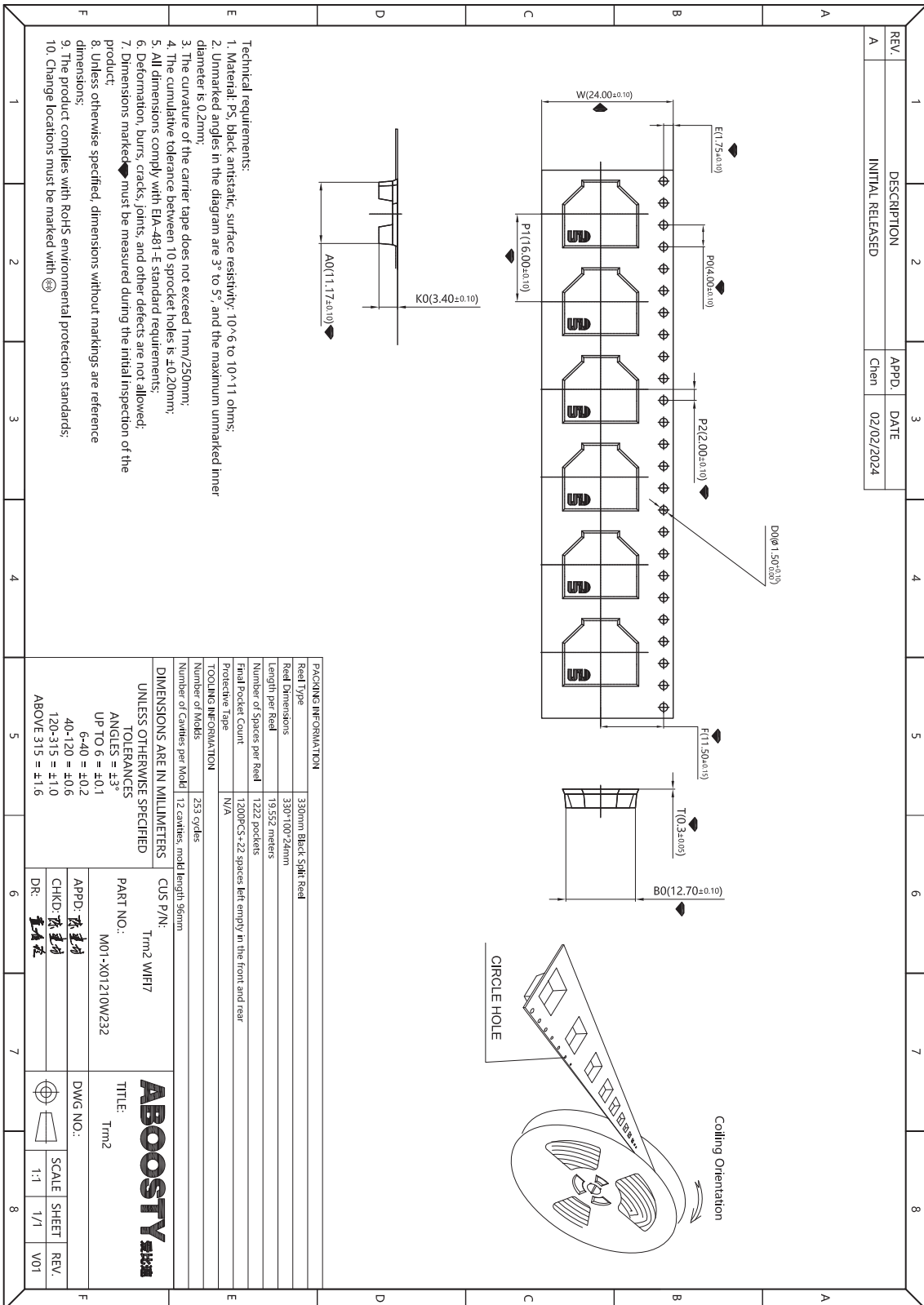









11 ANTENNA CERTIFICATION

RoHS Approval	Compliant [2011/65/EU&2015/863]
REACH Approval	Conform or declared [(EC)1907/2006]
Hazardous material regulation conformance: A certificate of conformance is available upon request. Feel free to consult us for details.	

Aboosty™ is owned by Shenzhen MyAntenna RF Technology Co., Ltd. (often abbreviated as MyAntenna).

WELCOME ALL ANTENNA OEM/ODM PROJECTS

Why Choose ABOOSTY

					
10+ years in antenna R&D, production, and OEM/ODM	MES system supported factory; 50M+ units annual output capacity	Factory directly competitive price	Quick price and lead time estimate	Innovative and patented design solutions	Professional team support & prompt reply within 24h

What We Provide

OEM/ODM Services	Light Customization	Deep Customization
	<ul style="list-style-type: none"> • Logo • Packaging • Cables&Connectors 	<ul style="list-style-type: none"> • In-depth tailoring for specific applications • Functional enhancements • Environmental adaptations • Vertical certifications • ...

Custom Process

Light Customization Process

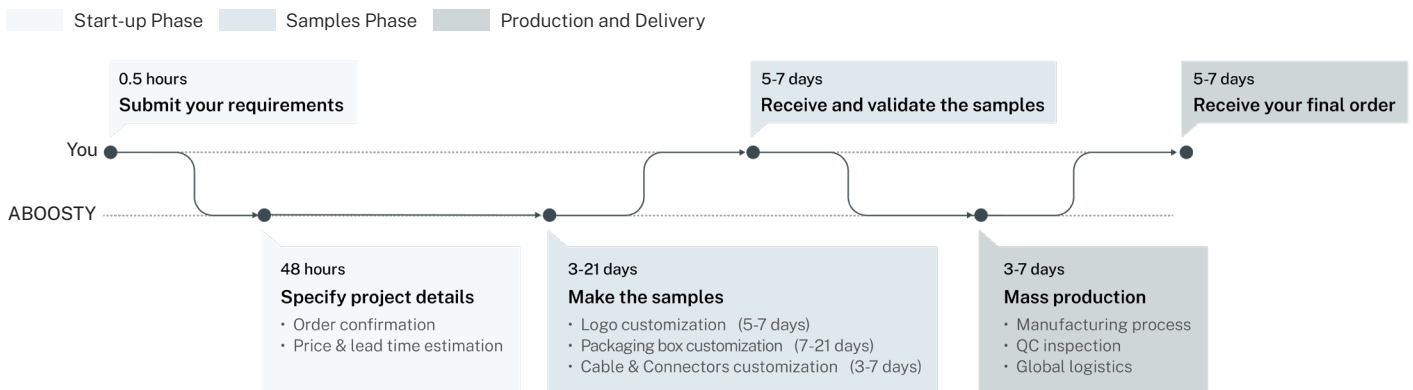

Deep Customization Process

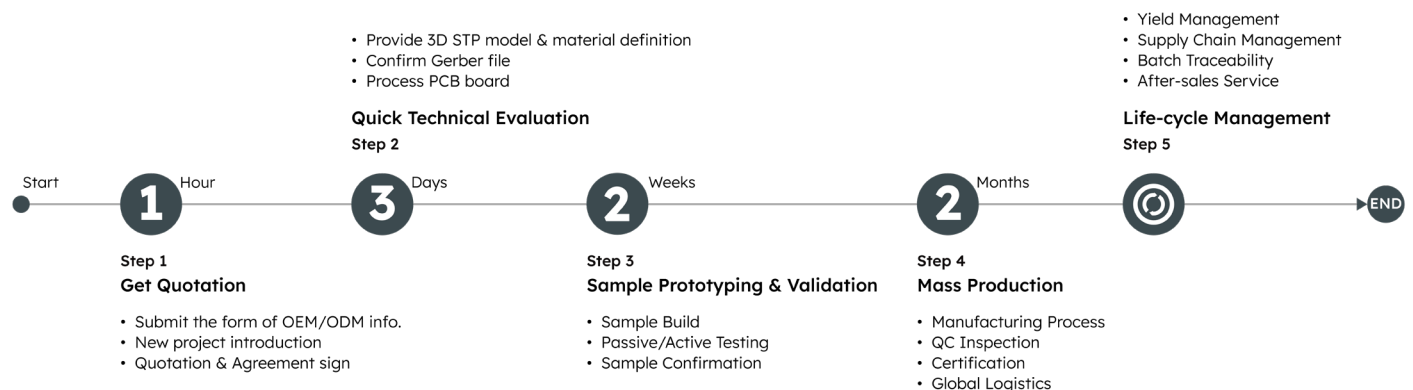

Note: You can let us handle the PCB prototyping or do it yourself. Choosing self-prototyping may add 2 to 5 weeks to the timeline.

Boost Your Signal
with Our Antennas

ABOOSTY

A Globally Leading Manufacturer and Supplier of
Multi-band Combination Antennas

Contact us:

 support@aboosty.com

 +86-13924678201

Visit us:

 www.aboosty.com

Search to follow us or to get technical support.



@Aboosty



Aboosty Antenna



Or click here to reach us directly.

