

2dBi 433-510MHz Fiberglass Antenna

FEATURES



The 2dBi Glass Fiber Antenna is an Omni 360-degree signal transmission and reception antenna, N-type male connector, 23.5x350mm lightweight antenna for indoor-outdoor 433-510MHz applications.

PRODUCTS

Part No.	Weight	Dimensions (L x W x H)	Connector	Color
M02-0400280R0A	136g	Φ23.5*350mm	N Type Male	White

SPECIFICATIONS

PARAMETER	SPECIFICATION
Frequency Bands, MHz	433-510
VSWR (Max)	3.0:1
Peak Gain, dBi (Typ)	Up to 2.2
Nominal Impedance	50 Ω
Max Power (ambient temp of 25°C)	10 Watts
Azimuth Beam Width (deg)	Omnidirectional
Polarization	Linear, Omnidirectional
Radome	Fiberglass pipe, White
Storage Temperature Range (°C)	-40° C to +85° C
Operational Temperature Range (°C)	-30° C to +80° C
Material Substance Compliance	REACH/RoHS Compliant
HSCODE	8517707090
USHSCODE	8517620010
UPC	

MyAntenna RF Technology Co., Ltd

ADD: No.RM 405, R3-A Building, Shenzhen High-Tech Park, Nanshan, Shenzhen, P.R. China.

TEL: +86-0755-86503881 FAX: +86-0755-27801677 E-mail: nfc@myantenna.com

ELECTRICAL DATA

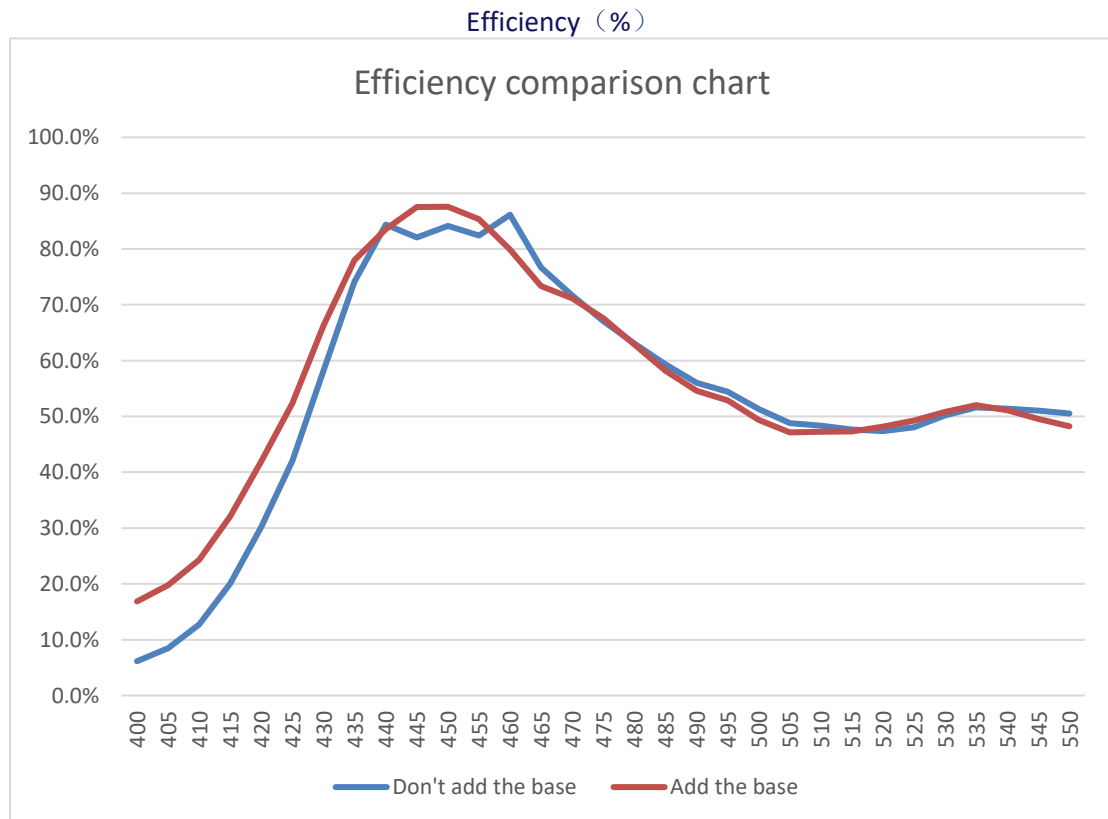
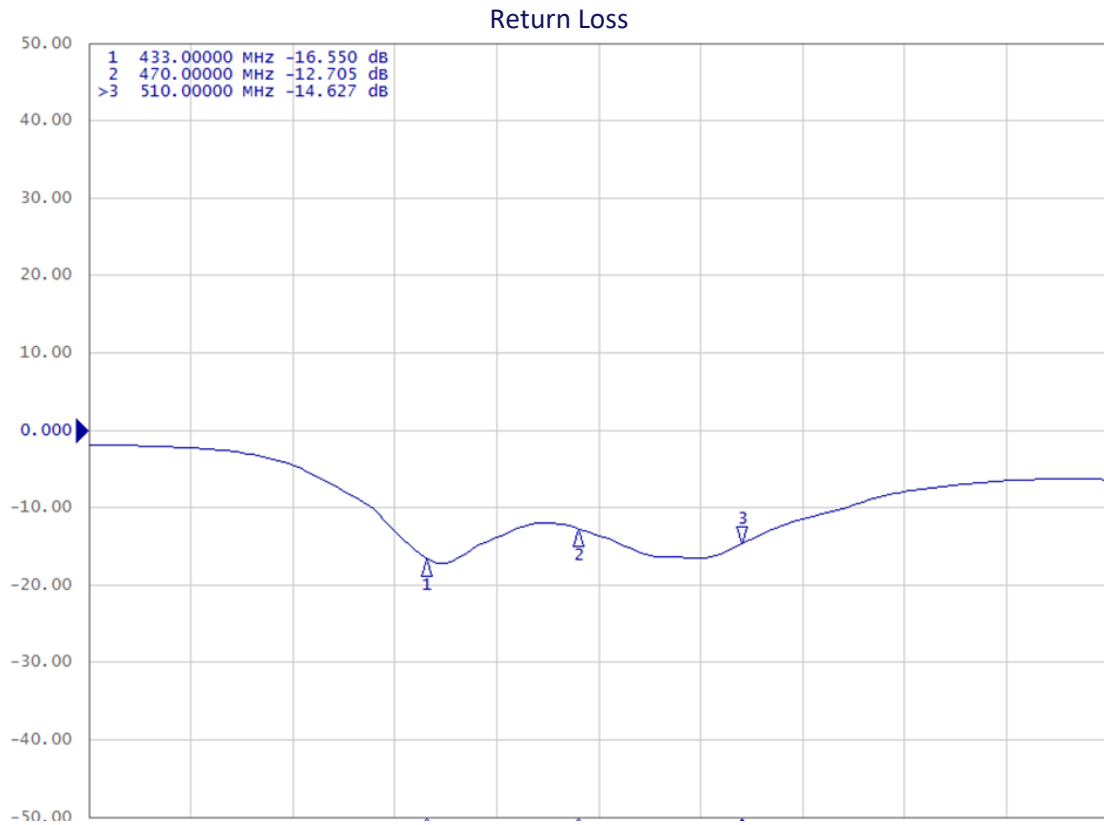

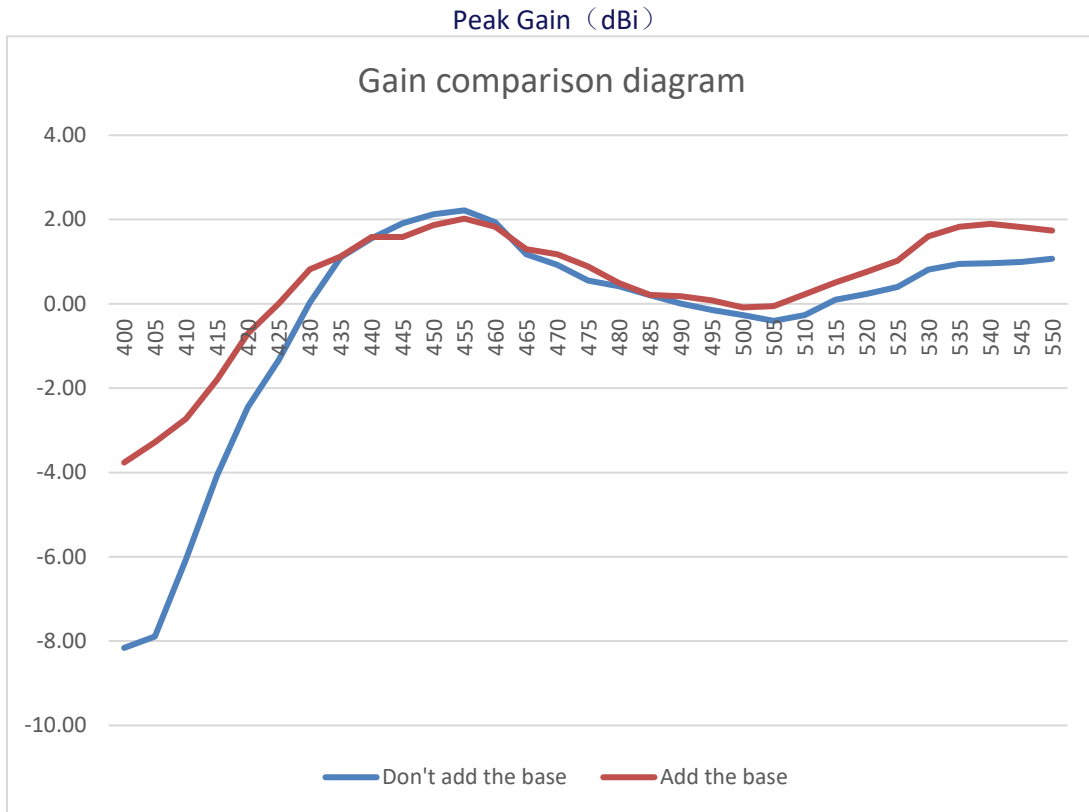

RADIATION PATTERNS

2D Radiation Pattern

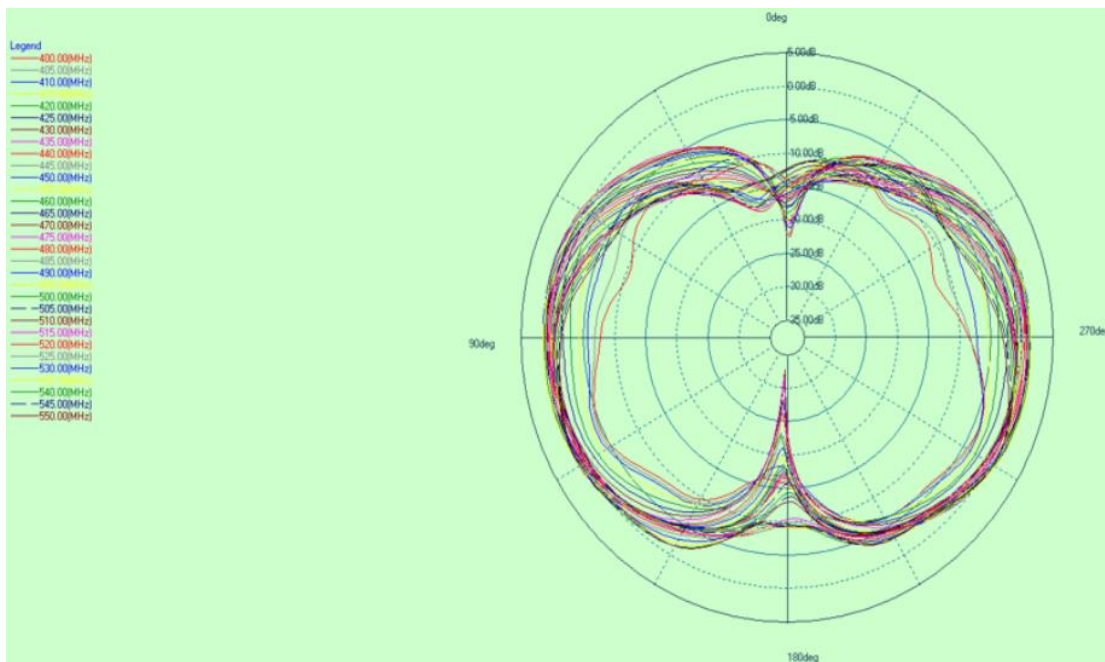

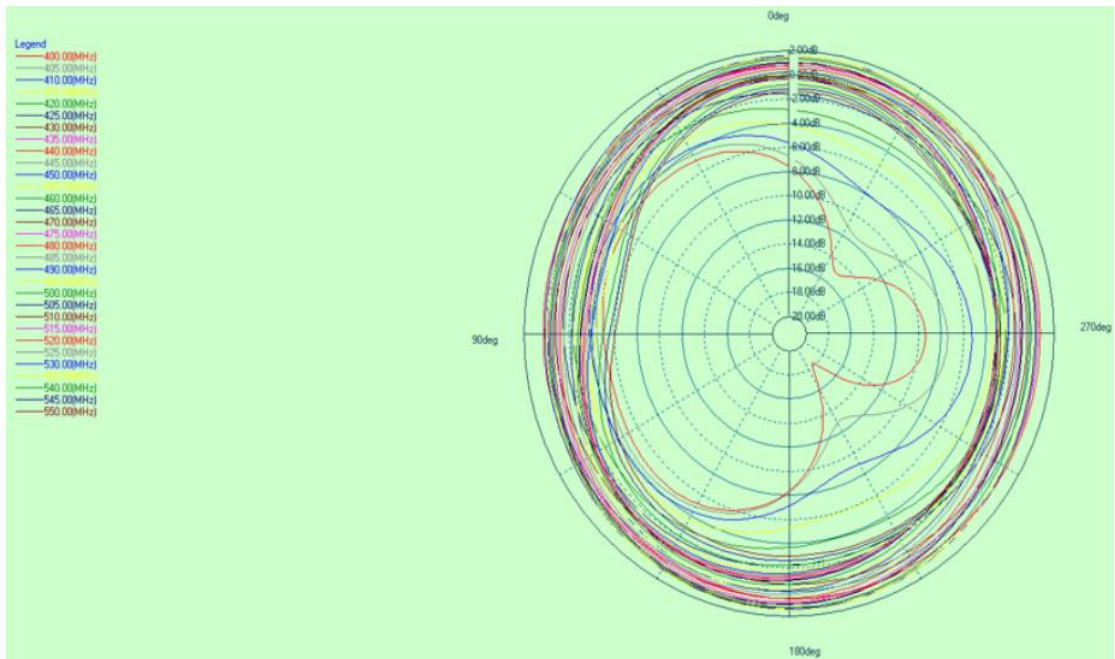
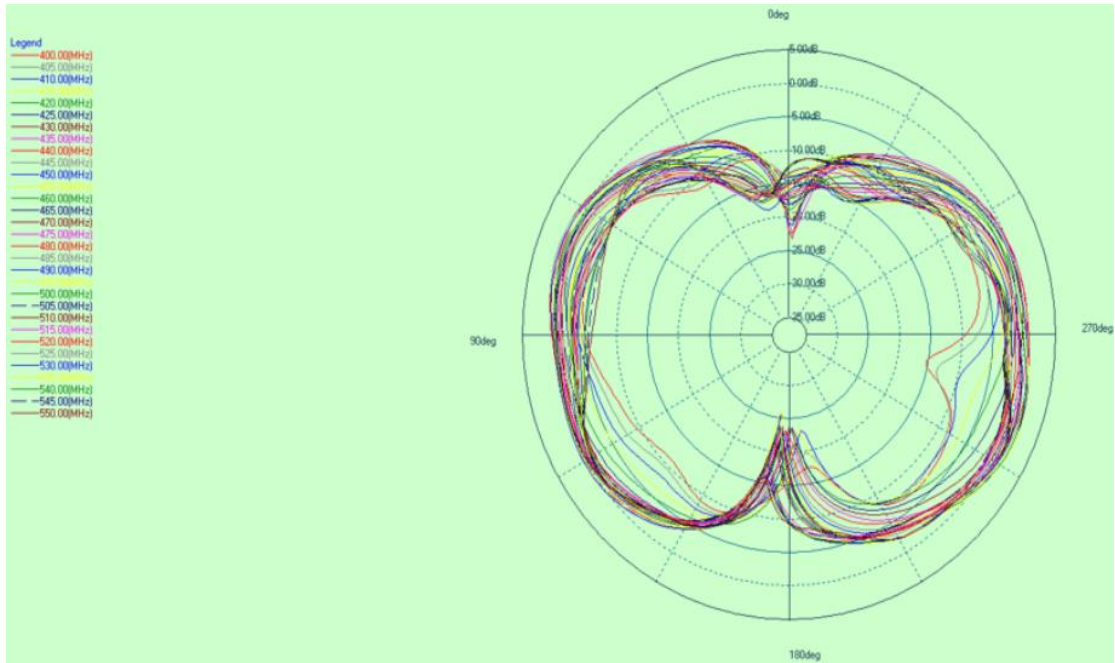

HOUSING CONFIGURATIONS

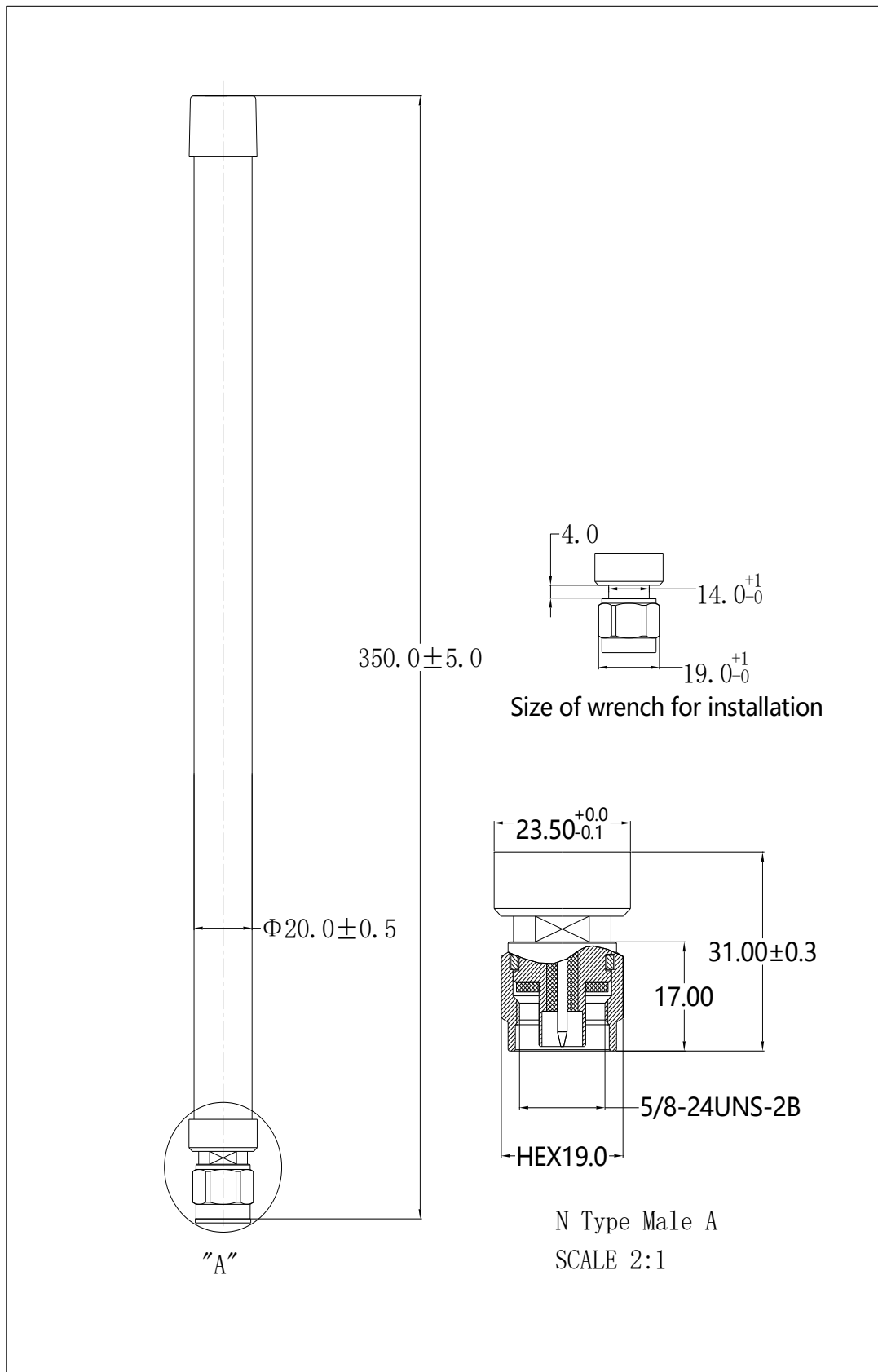

Fiberglass Antenna Mounting Methods 1



Fiberglass Antenna Mounting Methods 2

