

# Waterproof 5G Dipole Antenna

## FEATURES



- Adhesive Mount
- Ground Plane Independent
- Full 5GLTE backward compatibility
- 5.8 dBi Peak Gain
- Low Profile
- Customizable Cable and Connector



With overall dimensions of only 127.25\*22.0\*9.0mm, high-quality adhesive tape and PC/ABS UV stable housing, the M02-0100060R0A can be installed on any glass or ABS surfaces found in the most extreme outdoor environments without any risk of failure.

The antenna offers ground-plane independent Omni-directional performance across global cellular and 5G bands making it a versatile solution for any number of applications. The efficient element design ensures a high first-time connection rate and an ongoing, robust communications link even in problematic coverage areas.

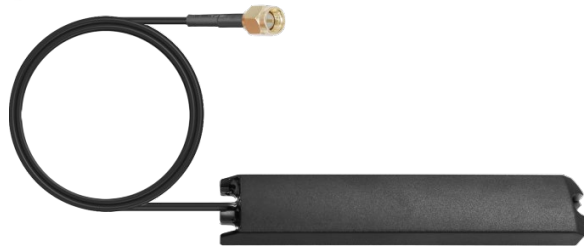

## PRODUCTS

Part No.	Weight	Dimensions (L x W x H)/Line length	Connector	Color
M02-0100060R0A	36g	127.25*22.0*9.0mm/1000mm	FAKRA type C female head	Black
M02-0100200R0A	36g	127.25*22.0*9.0mm/1000mm	SMA-Male	Black

## SPECIFICATIONS

PARAMETER	SPECIFICATION
Frequency Bands, MHz	617-6000
VSWR (Max)	3.0:1
Peak Gain, dBi (Typ)	Up to 4.67
Nominal Impedance	50 Ω
Max Power (ambient temp of 25°C)	10 Watts
Azimuth Beam Width (deg)	Omnidirectional
Polarization	Linear
Radome	PC+ABS+UV, Black
Storage Temperature Range (°C)	-40° C to +85° C
Operational Temperature Range (°C)	-30° C to +80° C
Material Substance Compliance	REACH/RoHS Compliant
HSCODE	8517707090
USHSCODE	8517620010
UPC	

## ELECTRICAL DATA

Return Loss

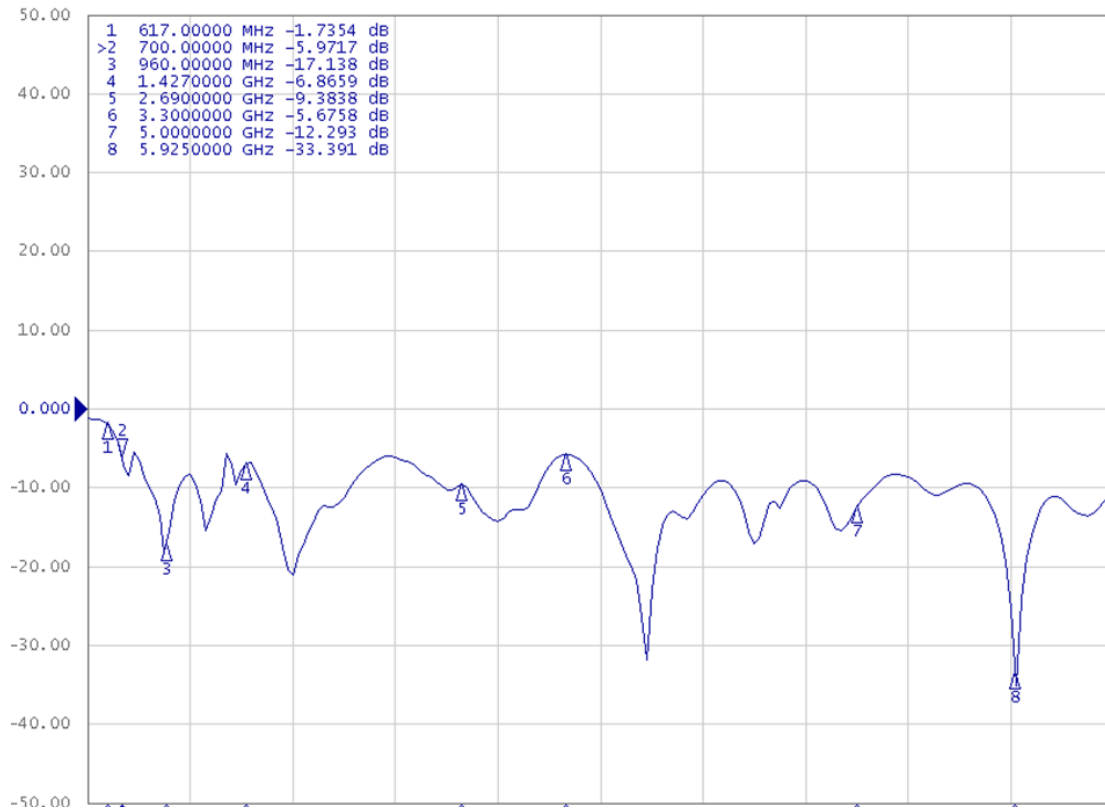

### Efficiency (%)

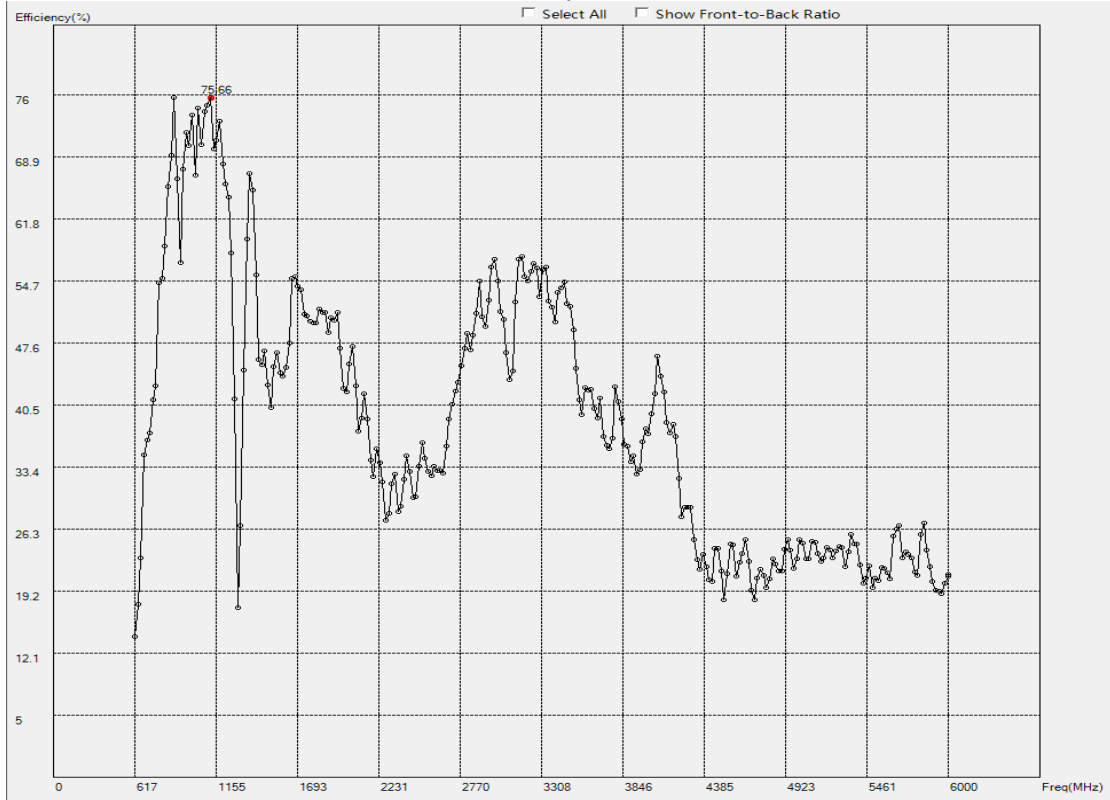

### Peak Gain (dBi)

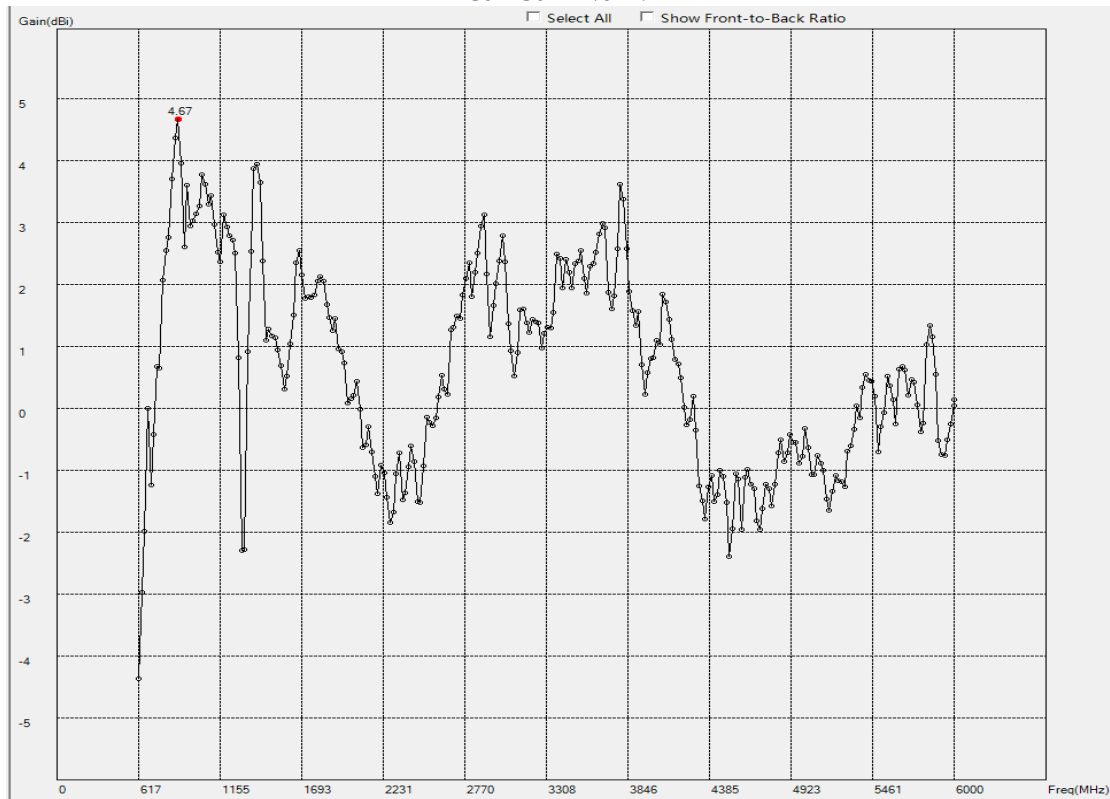

## RADIATION PATTERNS

### 2D Radiation Pattern at 937MHz

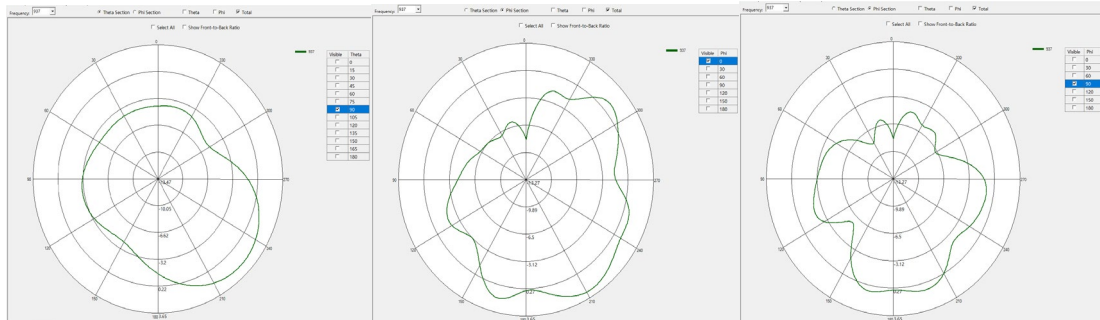

### 2D Radiation Pattern at 2457MHz

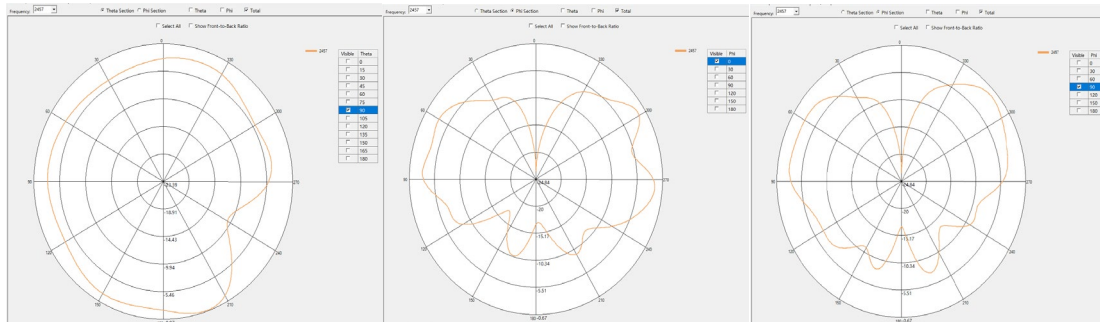

HOUSING CONFIGURATIONS (Farka)

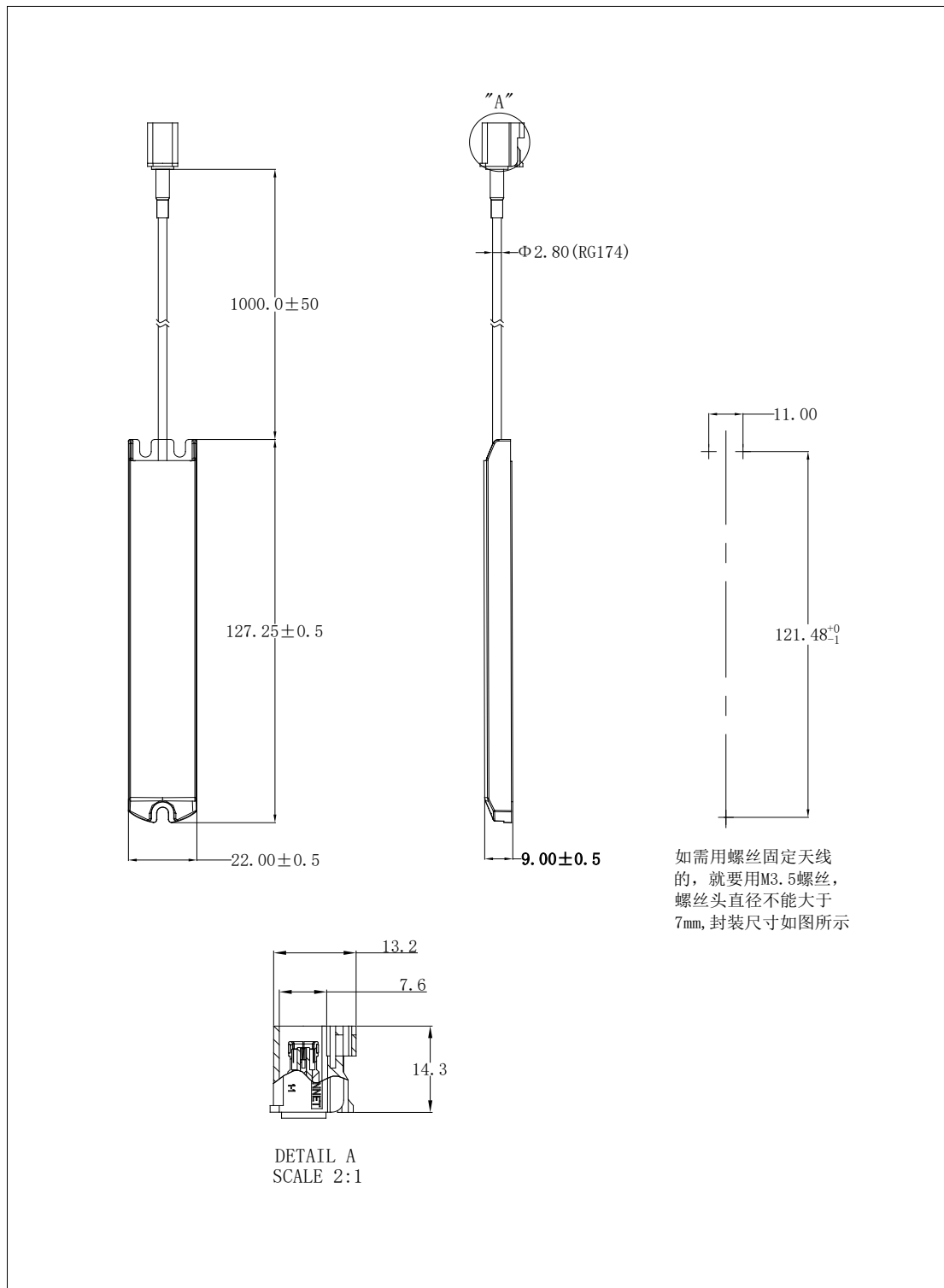

HOUSING CONFIGURATIONS (SMA-Male)

